

galileo's experiment
inclined plane

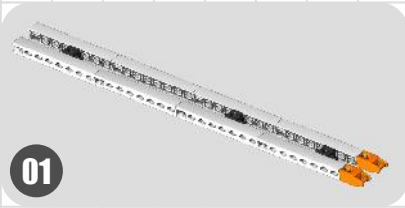

01

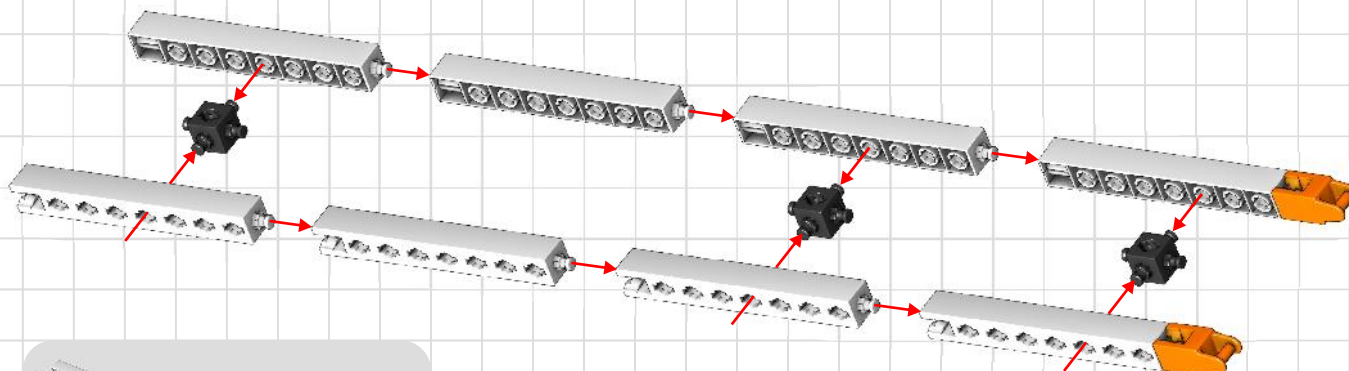
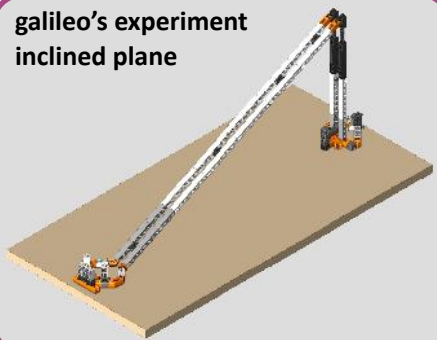
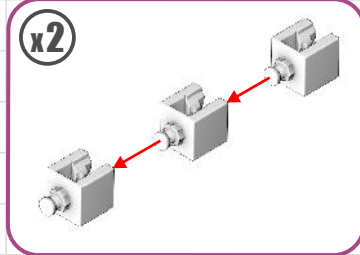

x2

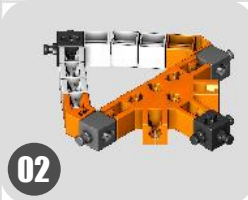
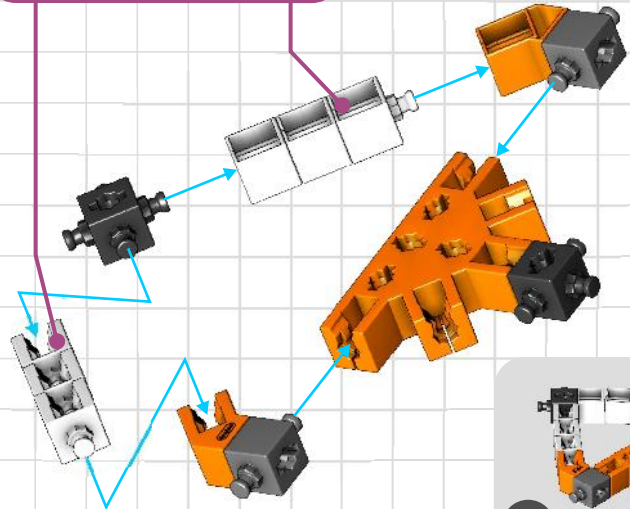

02

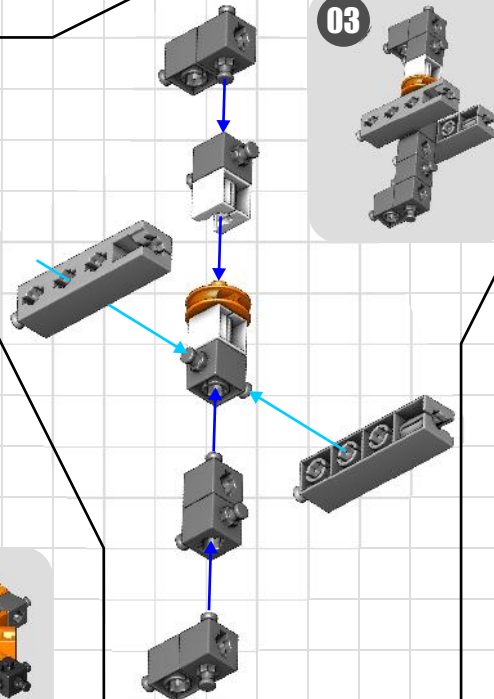

03

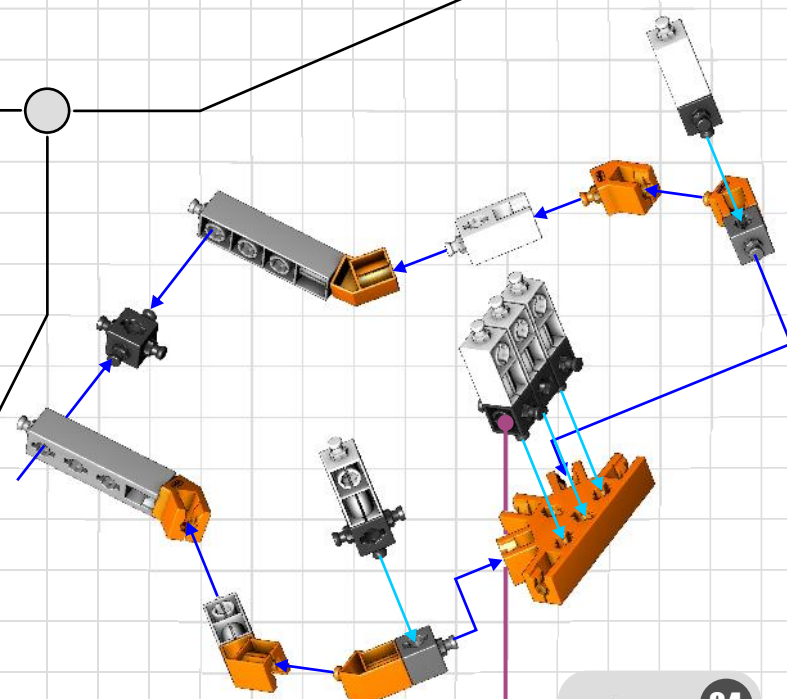

04

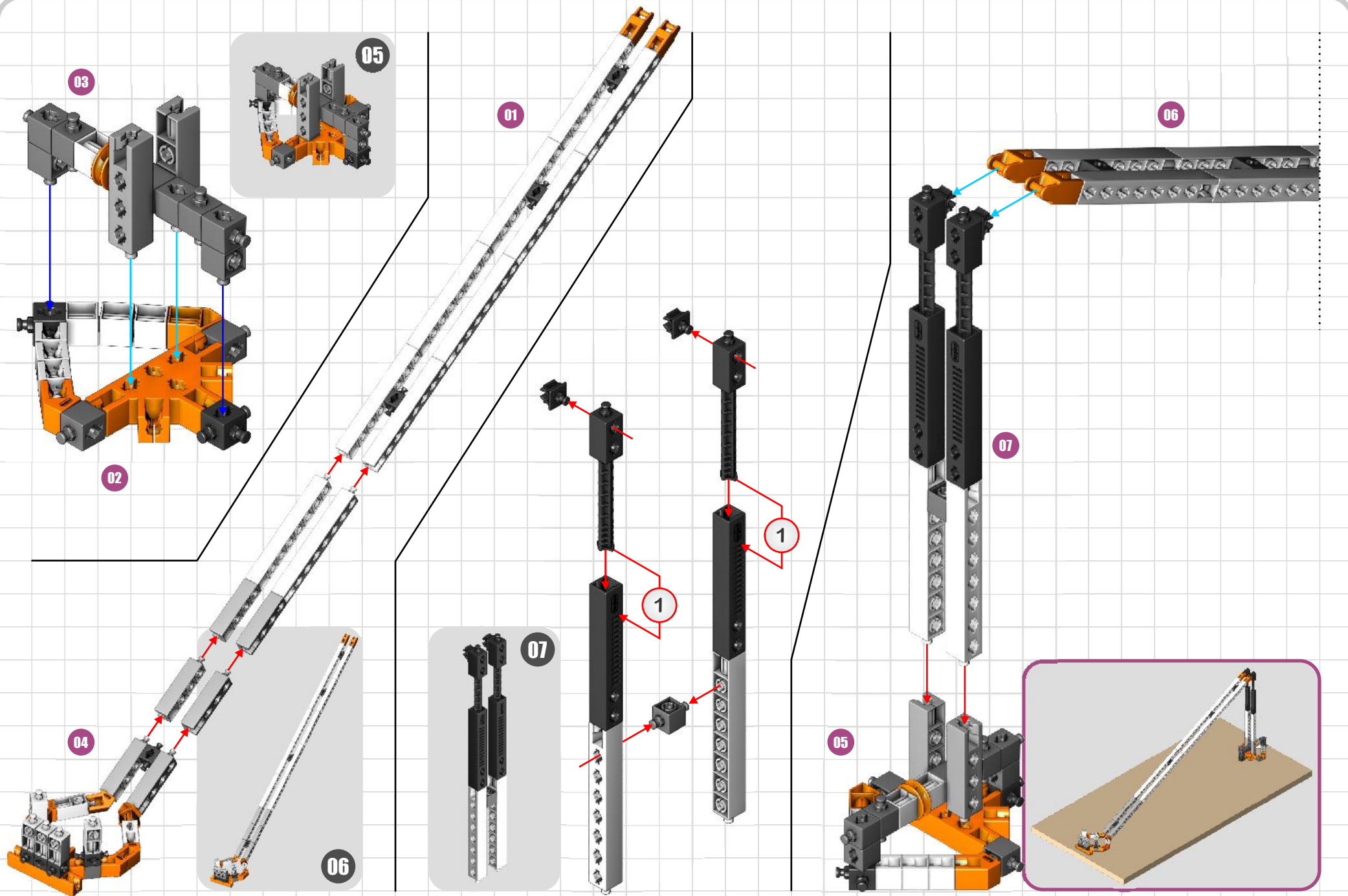

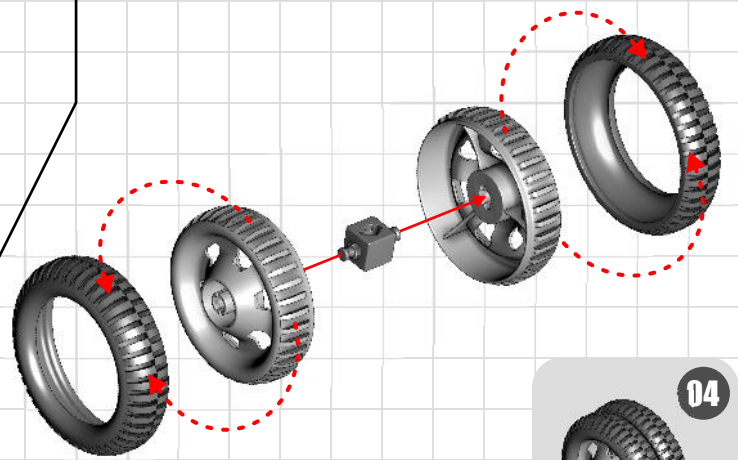
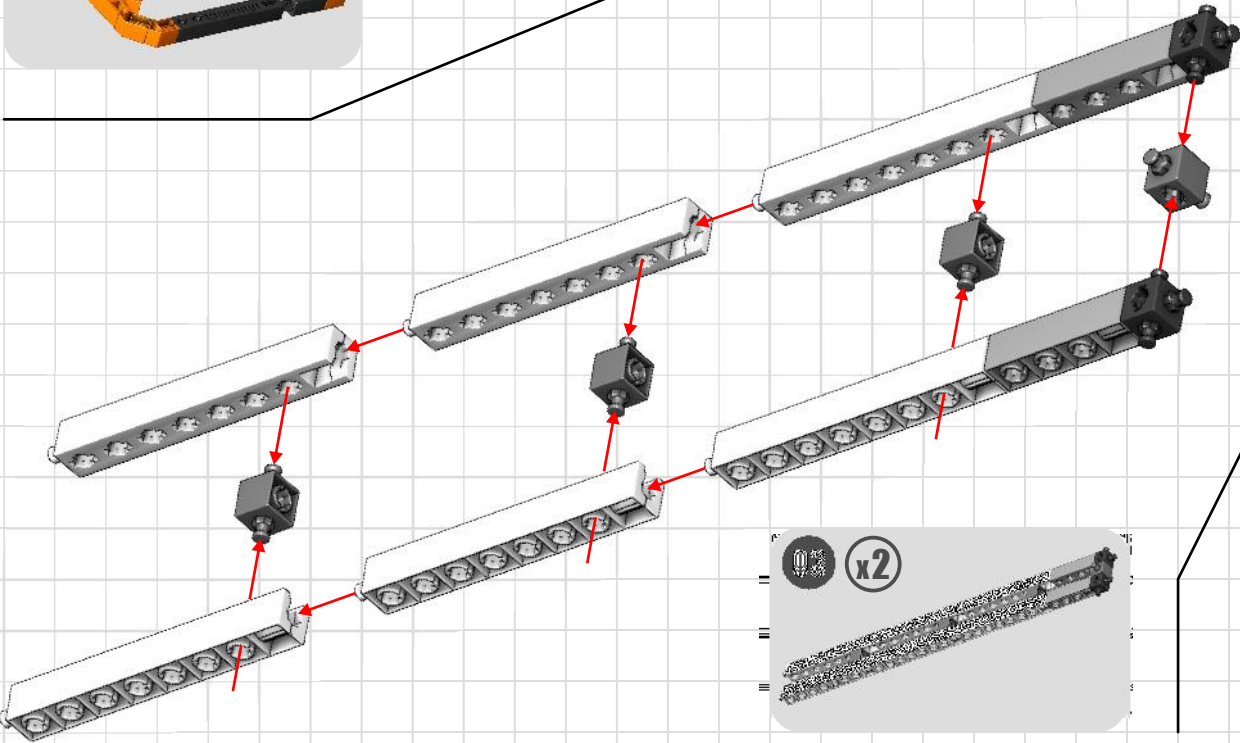
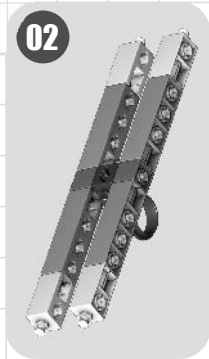
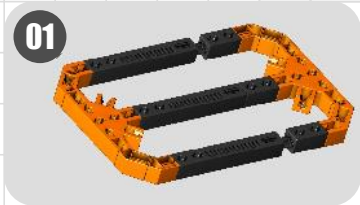
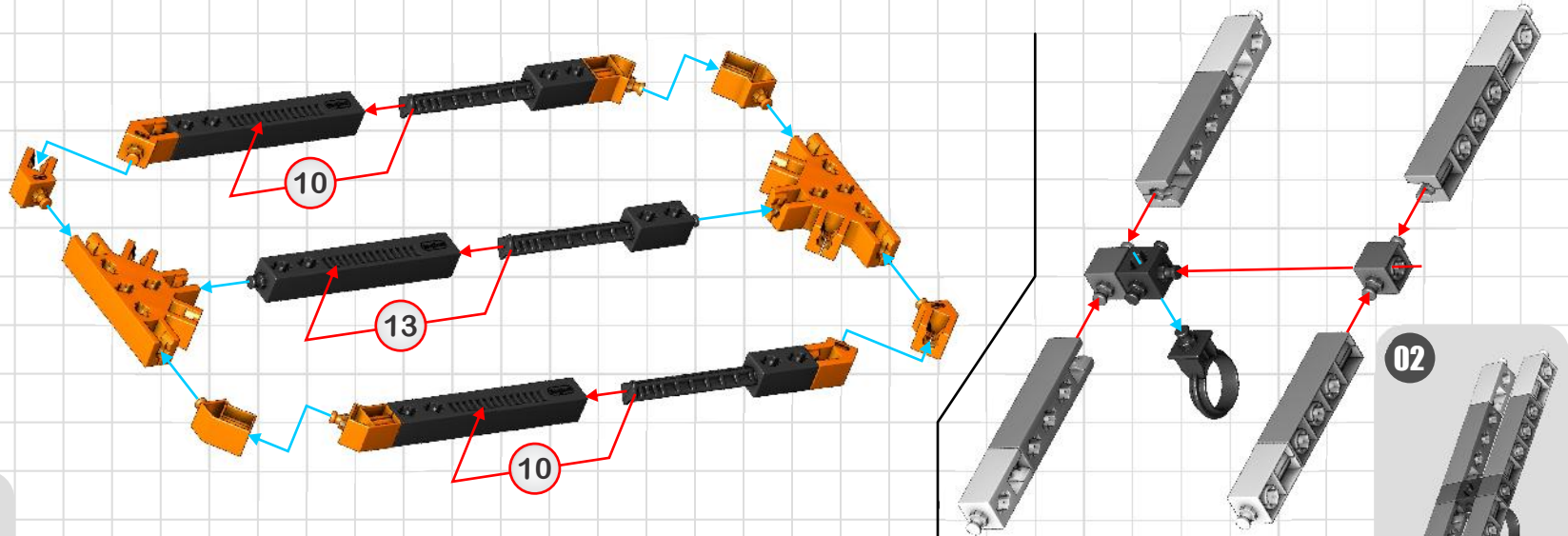

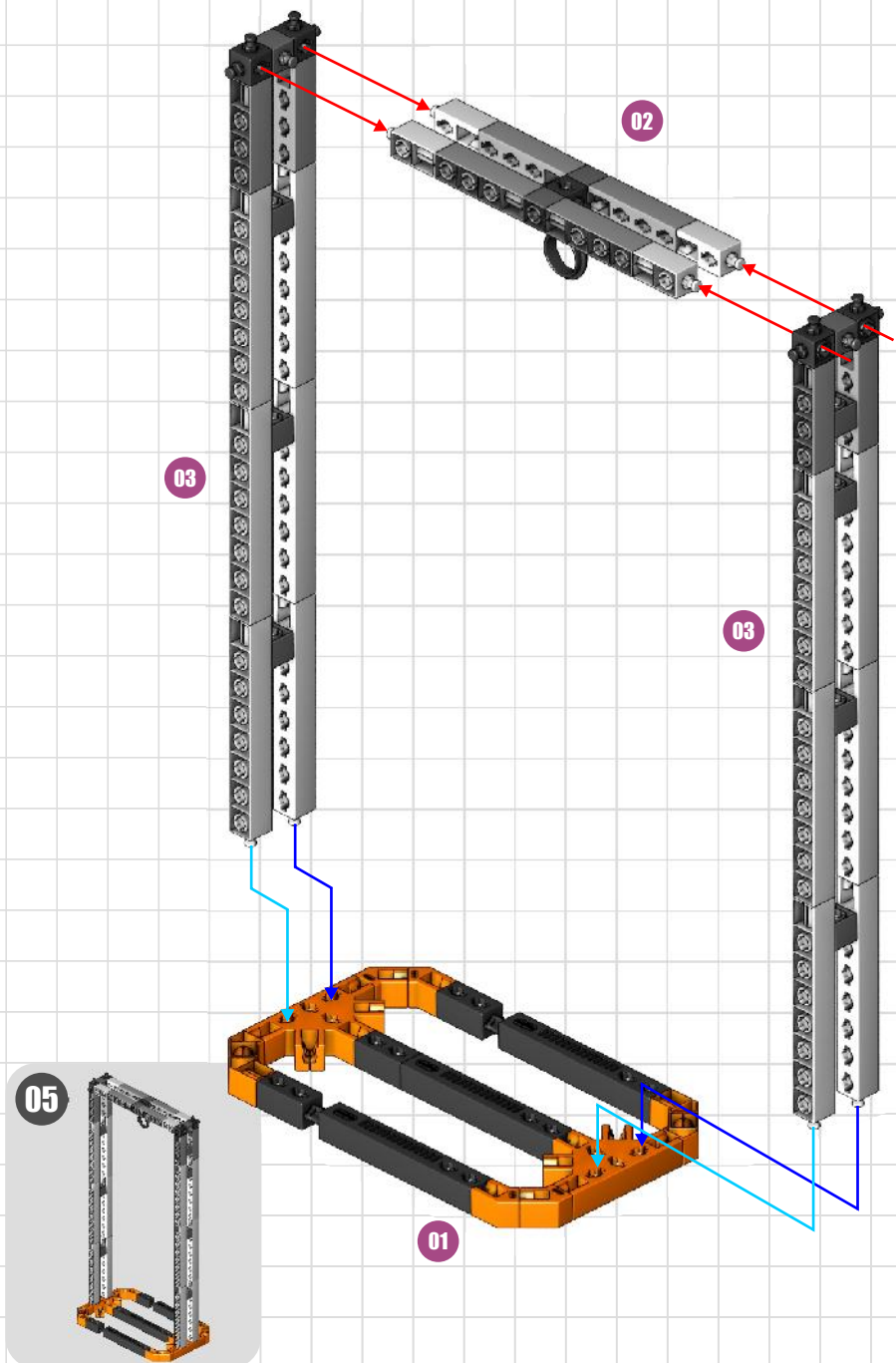

02

